



Two-Tier Terrace Pro

Living Lettuce Growing Calendar

17-week Planting to Harvest Guide

[*To be used in conjunction with the Terrace Pro How-to Guide and Growing Guide](#)



Living Lettuce Grow Kit Overview

The following table outlines the key activities and production time of your Living Lettuce crop:

Crop	Crop Icon	Key Actions**	Total Time for Production*	Total Number of Harvests
Lettuce		<ul style="list-style-type: none">● Start● Grow○ Transplant● Harvest	6-8 weeks	48 heads

**Note that harvest timelines will vary depending on growing conditions and plant growth*

***Your Grow Guides provide detailed instructions for each of these important growing activities*

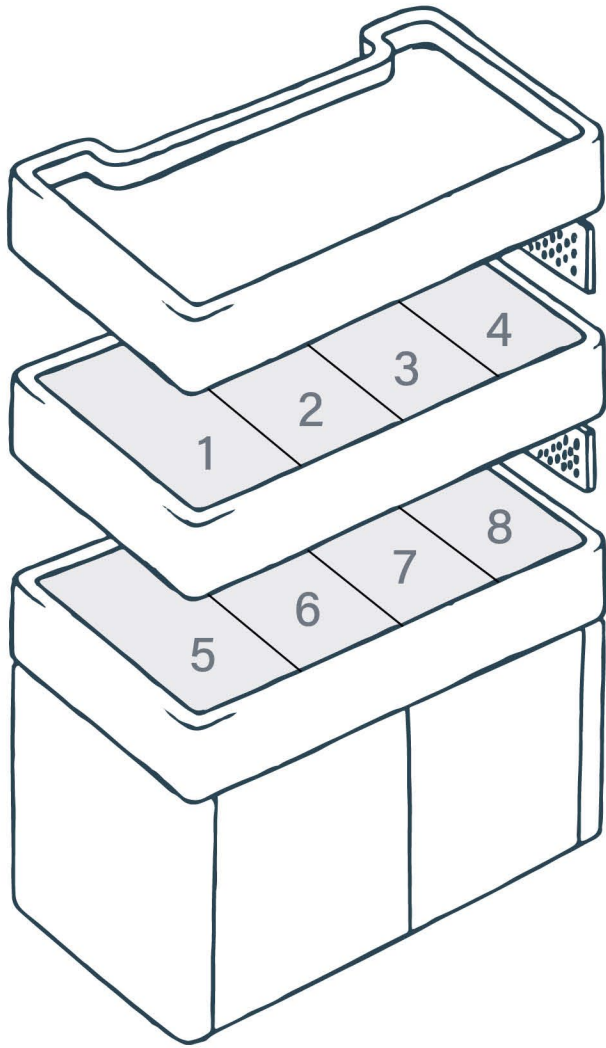

Before You Start: Understanding Your Growing Space

The following schedule provides detailed bi-weekly instructions for each of the 12 growing slots shown in this diagram. Note that there will be some weeks when growing spots are empty. This ensures that your Living Lettuce heads have room to grow as they mature.

Day 1

 Start  Growing  Transplant  Harvest

Tray 1  L Start 12 Heads Lettuce - Mix of Varieties.	Tray 2	Tray 3	Tray 4
---	--------	--------	--------

Tray 5	Tray 6	Tray 7	Tray 8
--------	--------	--------	--------

Day 7

Tray 1  L Grow Lettuce.	Tray 2	Tray 3	Tray 4
--	--------	--------	--------

Tray 5	Tray 6	Tray 7	Tray 8
--------	--------	--------	--------

Day 14

● Start ● Growing ○ Transplant ● Harvest

Tray 1  L	Grow Lettuce.	Tray 2	Tray 3	Tray 4
---	---------------	--------	--------	--------

Tray 5  L	Start 12 Heads Lettuce - Mix of Varieties.	Tray 6	Tray 7	Tray 8
---	--	--------	--------	--------





Day 21

Tray 1  L	Transplant Lettuce – Blocks can stay within Tray 1.	Tray 2	Tray 3	Tray 4
--	---	--------	--------	--------

Tray 5  L	Grow Lettuce.	Tray 6	Tray 7	Tray 8
---	---------------	--------	--------	--------





Day 28

 Start  Growing  Transplant  Harvest

Tray 1  L	Start 12 Heads Lettuce – Mix of Varieties.	Tray 2  L	Move 4 Heads from Tray 1.	Tray 3  L	Move 4 Heads from Tray 1.	Tray 4  L	Move 4 Heads from Tray 1.
---	--	--	---------------------------	--	---------------------------	--	---------------------------

Tray 5  L	Grow Lettuce.	Tray 6	Tray 7	Tray 8
---	---------------	--------	--------	--------









Day 35

Tray 1  L	Grow Lettuce.	Tray 2  L	Grow Lettuce.	Tray 3  L	Grow Lettuce.	Tray 4  L	Grow Lettuce.
---	---------------	--	---------------	--	---------------	--	---------------









Tray 5  L	Transplant Lettuce – Blocks can stay within Tray 5.	Tray 6	Tray 7	Tray 8
---	---	--------	--------	--------

Day 42

● Start ● Growing ○ Transplant ● Harvest

Tray 1  L	Grow Lettuce.	Tray 2  L	Grow Lettuce.	Tray 3  L	Grow Lettuce.	Tray 4  L	Grow Lettuce.
Tray 5  L	Start 12 Heads Lettuce – Mix of Varieties.	Tray 6  L	Move 4 Heads from Tray 5.	Tray 7  L	Move 4 Heads from Tray 5.	Tray 8  L	Move 4 Heads from Tray 5.

Day 49

Tray 1  L	Transplant Lettuce – Blocks can stay within Tray 1	Tray 2  L	Grow Lettuce.	Tray 3  L	Grow Lettuce.	Tray 4  L	Grow Lettuce.
Tray 5  L	Grow Lettuce.	Tray 6  L	Grow Lettuce.	Tray 7  L	Grow Lettuce.	Tray 8  L	Grow Lettuce.













In order to continue producing gourmet greens with your Terrace Pro, you will need to re-order Grow Kits and refill your seeds and growing media stock. Visit www.lesverts.com for a full complement of replacement kits, including all the delicious items you've been growing to date.







Day 56





● Start ● Growing ○ Transplant ● Harvest

Tray 1  L Start 12 Heads Lettuce – Mix of Varieties.	Tray 2  L  L Harvest 4 Heads Mature Lettuce. Move 4 Heads from Tray 1.	Tray 3  L  L Harvest 4 Heads Mature Lettuce. Move 4 Heads from Tray 1.	Tray 4  L  L Harvest 4 Heads Mature Lettuce. Move 4 Heads from Tray 1.
---	--	--	--

Tray 5  L Grow Lettuce.	Tray 6  L Grow Lettuce.	Tray 7  L Grow Lettuce.	Tray 8  L Grow Lettuce.
--	---	---	---











Day 63

Tray 1  L Grow Lettuce.	Tray 2  L Grow Lettuce.	Tray 3  L Grow Lettuce.	Tray 4  L Grow Lettuce.
--	---	---	---







Tray 5  L Transplant Lettuce – Blocks can stay within Tray 5.	Tray 6  L Grow Lettuce.	Tray 7  L Grow Lettuce.	Tray 8  L Grow Lettuce.
--	---	---	---

Day 70

● Start ● Growing ○ Transplant ● Harvest









Tray 1  L Grow Lettuce.	Tray 2  L Grow Lettuce.	Tray 3  L Grow Lettuce.	Tray 4  L Grow Lettuce.
Tray 5	Tray 6  L  L Harvest 4 Heads Mature Lettuce. Move 4 Heads from Tray 5.	Tray 7  L  L Harvest 4 Heads Mature Lettuce. Move 4 Heads from Tray 5.	Tray 8  L  L Harvest 4 Heads Mature Lettuce. Move 4 Heads from Tray 5.

Day 77







Tray 1  L Transplant Lettuce – Blocks can stay within Tray 1.	Tray 2  L Grow Lettuce.	Tray 3  L Grow Lettuce.	Tray 4  L Grow Lettuce.
Tray 5	Tray 6  L Grow Lettuce.	Tray 7  L Grow Lettuce.	Tray 8  L Grow Lettuce.

Day 84

● Start ● Growing ○ Transplant ● Harvest







Tray 1	Tray 2   L L Harvest 4 Heads Mature Lettuce. Move 4 Heads from Tray 1.	Tray 3   L L Harvest 4 Heads Mature Lettuce. Move 4 Heads from Tray 1.	Tray 4   L L Harvest 4 Heads Mature Lettuce. Move 4 Heads from Tray 1.
Tray 5	Tray 6  L Grow Lettuce.	Tray 7  L Grow Lettuce.	Tray 8  L Grow Lettuce.

Day 91



Tray 1	Tray 2  L Grow Lettuce.	Tray 3  L Grow Lettuce.	Tray 4  L Grow Lettuce.
Tray 5	Tray 6  L Grow Lettuce.	Tray 7  L Grow Lettuce.	Tray 8  L Grow Lettuce.

Day 98

● Start ● Growing ○ Transplant ● Harvest



Tray 1	Tray 2	Grow Lettuce.	Tray 3	Grow Lettuce.	Tray 4	Grow Lettuce.
						
Tray 5	Tray 6	Harvest 4 Heads Mature Lettuce.	Tray 7	Harvest 4 Heads Mature Lettuce.	Tray 8	Harvest 4 Heads Mature Lettuce.
						

Day 105

Tray 1	Tray 2	Grow Lettuce.	Tray 3	Grow Lettuce.	Tray 4	Grow Lettuce.
						
Tray 5	Tray 6		Tray 7		Tray 8	

Day 112

● Start ● Growing ○ Transplant ● Harvest

Tray 1	Tray 2  L Harvest 4 Heads Mature Lettuce.	Tray 3  L Harvest 4 Heads Mature Lettuce.	Tray 4  L Harvest 4 Heads Mature Lettuce.
Tray 5	Tray 6	Tray 7	Tray 8
