



Two-Tier Terrace Pro

Fresh Living Herbs Growing Calendar

15-week Planting to Harvest Guide

[*To be used in conjunction with the Terrace Pro How-to Guide and Growing Guide](#)



Fresh Living Herb Grow Kit Overview

The following table outlines the key activities and production time of your Fresh Herb crop:

Crop	Crop Icon	Key Actions**	Total Time for Production*	Total Number of Harvests
Living Herbs		<ul style="list-style-type: none">● Start● Grow● Harvest	6-8 weeks	180 bunches

**Note that harvest timelines will vary depending on growing conditions and plant growth*

***Your Terrace Pro Grow Guide provides detailed instructions for each of these important growing activities*

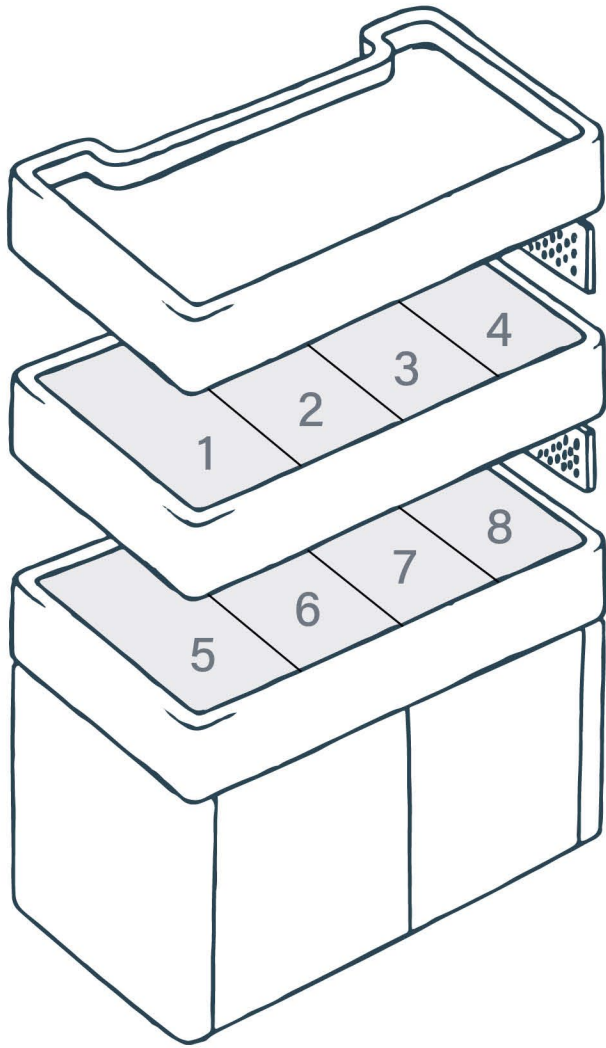

Before You Start: Understanding Your Growing Space

The following schedule provides detailed bi-weekly instructions for each of the 12 growing slots (Trays) shown in this diagram. Note that there will be some weeks when growing spots are empty. This ensures that your Fresh Living Herbs will have room to grow as they mature.

Day 1

 Start  Growing  Transplant  Harvest

Tray 1  H Start 30 Mini Blocks – Mix of Types.	Tray 2	Tray 3	Tray 4
---	--------	--------	--------

Tray 5	Tray 6	Tray 7	Tray 8
--------	--------	--------	--------

Day 7

Tray 1  H Grow Herbs.	Tray 2	Tray 3	Tray 4
--	--------	--------	--------

Tray 5  H Start 30 Mini Blocks – Mix of Types.	Tray 6	Tray 7	Tray 8
---	--------	--------	--------





Day 14

● Start ● Growing ○ Transplant ● Harvest

Tray 1  H Grow Herbs.	Tray 2	Tray 3	Tray 4
--	--------	--------	--------

Tray 5  H Grow Herbs.	Tray 6	Tray 7	Tray 8
--	--------	--------	--------









Day 21

Tray 1  H Start 30 Mini Blocks – Mix of Types.	Tray 2  H Move 10 Blocks from Tray 1.	Tray 3  H Move 10 Blocks from Tray 1.	Tray 4  H Move 10 Blocks from Tray 1.
---	---	---	---









Tray 5  H Grow Herbs.	Tray 6	Tray 7	Tray 8
--	--------	--------	--------

Day 28

● Start ● Growing ○ Transplant ● Harvest

Tray 1  H	Grow Herbs.	Tray 2  H	Grow Herbs.	Tray 3  H	Grow Herbs.	Tray 4  H	Grow Herbs.
Tray 5  H	Start 30 Mini Blocks – Mix of Types.	Tray 6  H	Move 10 Blocks from Tray 5.	Tray 7  H	Move 10 Blocks from Tray 5.	Tray 8  H	Move 10 Blocks from Tray 5.

Day 35

Tray 1  H	Grow Herbs.	Tray 2  H	Grow Herbs.	Tray 3  H	Grow Herbs.	Tray 4  H	Grow Herbs.
Tray 5  H	Grow Herbs.	Tray 6  H	Grow Herbs.	Tray 7  H	Grow Herbs.	Tray 8  H	Grow Herbs.













In order to continue producing gourmet greens with your Terrace Pro, you will need to re-order Grow Kits and refill your seeds and growing media stock. Visit www.lesverts.com for a full complement of replacement kits, including all the delicious items you've been growing to date.













Day 42

 Start  Growing  Transplant  Harvest









<p>Tray 1</p>  <p>H</p>	<p>Start 30 Mini Blocks – Mix of Types.</p>	<p>Tray 2</p>   <p>H H</p>	<p>Tray 3</p>   <p>H H</p>	<p>Tray 4</p>   <p>H H</p>
<p>Tray 5</p>  <p>H</p>	<p>Tray 6</p>  <p>H</p>	<p>Tray 7</p>  <p>H</p>	<p>Tray 8</p>  <p>H</p>	

Day 49







<p>Tray 1</p>  <p>H</p>	<p>Tray 2</p>  <p>H</p>	<p>Tray 3</p>  <p>H</p>	<p>Tray 4</p>  <p>H</p>
<p>Tray 5</p>  <p>H</p>	<p>Tray 6</p>   <p>H H</p>	<p>Tray 7</p>   <p>H H</p>	<p>Tray 8</p>   <p>H H</p>

Day 56

● Start ● Growing ○ Transplant ● Harvest









Tray 1  H Grow Herbs.	Tray 2  H Grow Herbs.	Tray 3  H Grow Herbs.	Tray 4  H Grow Herbs.
Tray 5  H Grow Herbs.	Tray 6  H Grow Herbs.	Tray 7  H Grow Herbs.	Tray 8  H Grow Herbs.

Day 63







Tray 1	Tray 2  H Harvest Herbs – Entire Plant or Prune and Grow. Move 10 Blocks from Tray 1.	Tray 3  H Harvest Herbs – Entire Plant or Prune and Grow. Move 10 Blocks from Tray 1.	Tray 4  H Harvest Herbs – Entire Plant or Prune and Grow. Move 10 Blocks from Tray 1.
Tray 5  H Grow Herbs.	Tray 6  H Grow Herbs.	Tray 7  H Grow Herbs.	Tray 8  H Grow Herbs.

Day 70

● Start ● Growing ○ Transplant ● Harvest









Tray 1	Tray 2	Grow Herbs.	Tray 3	Grow Herbs.	Tray 4	Grow Herbs.
	 H		 H		 H	
Tray 5	Tray 6	Harvest Herbs – Entire Plant or Prune and Grow. Move 10 Blocks from Tray 5.	Tray 7	Harvest Herbs – Entire Plant or Prune and Grow. Move 10 Blocks from Tray 5.	Tray 8	Harvest Herbs – Entire Plant or Prune and Grow. Move 10 Blocks from Tray 5.
	 H	 H	 H	 H	 H	 H

Day 77







Tray 1	Tray 2	Grow Herbs.	Tray 3	Grow Herbs.	Tray 4	Grow Herbs.
	 H		 H		 H	
Tray 5	Tray 6	Grow Herbs.	Tray 7	Grow Herbs.	Tray 8	Grow Herbs.
	 H		 H		 H	

Day 84

 Start  Growing  Transplant  Harvest

Tray 1	Tray 2   H H Harvest Herbs – Entire Plant or Prune and Grow. Move 10 Blocks from Tray 1.	Tray 3   H H Harvest Herbs – Entire Plant or Prune and Grow. Move 10 Blocks from Tray 1.	Tray 4   H H Harvest Herbs – Entire Plant or Prune and Grow. Move 10 Blocks from Tray 1.
Tray 5	Tray 6  H Grow Herbs.	Tray 7  H Grow Herbs.	Tray 8  H Grow Herbs.



Day 91

Tray 1	Tray 2	Tray 3	Tray 4
Tray 5	Tray 6   H H Harvest Herbs – Entire Plant or Prune and Grow. Move 10 Blocks from Tray 5.	Tray 7   H H Harvest Herbs – Entire Plant or Prune and Grow. Move 10 Blocks from Tray 5.	Tray 8   H H Harvest Herbs – Entire Plant or Prune and Grow. Move 10 Blocks from Tray 5.

Day 91

● Start ● Growing ○ Transplant ● Harvest

Tray 1	Tray 2	Tray 3	Tray 4
--------	--------	--------	--------

Tray 5	Tray 6  H Harvest Herbs – Entire Plant or Prune and Grow.	Tray 7  H Harvest Herbs – Entire Plant or Prune and Grow.	Tray 8  H Harvest Herbs – Entire Plant or Prune and Grow.
--------	---	---	---

Day 98

Tray 1	Tray 2	Tray 3	Tray 4
--------	--------	--------	--------

Tray 5	Tray 6	Tray 7	Tray 8
--------	--------	--------	--------