



Two-Tier Terrace Pro

# Fresh Harvest Growing Calendar





19-week Planting to Harvest Guide

[\\*To be used in conjunction with the Terrace Pro How-to Guide and Growing Guide](#)



# Fresh Harvest Grow Kit Overview

Each of the crops from the Fresh Harvest Grow Kit vary in their time from planting to harvest. The following table outlines the key activities and production time of each crop:

Crop	Crop Icon	Key Actions**	Total Time for Production*	Total Number of Harvests
Microgreens	 MG	● Start, ● Grow, ● Harvest	2-3 weeks	4 trays
Babygreens	 BG	● Start, ● Grow, ● Harvest	3-4 weeks	2 trays
Baby Leaf	 BL	● Start, ● Grow, ● Harvest	3-4 weeks	2 trays
Lettuce	 L	● Start, ● Grow, ○ Transplant, ● Harvest	6-8 weeks	48 heads
Herbs	 H	● Start, ● Grow, ● Harvest	5-6 weeks	20 bunches

*\*Note that harvest timelines will vary depending on growing conditions and plant growth*

*\*\*Your Grow Guides provide detailed instructions for each of these important growing activities*

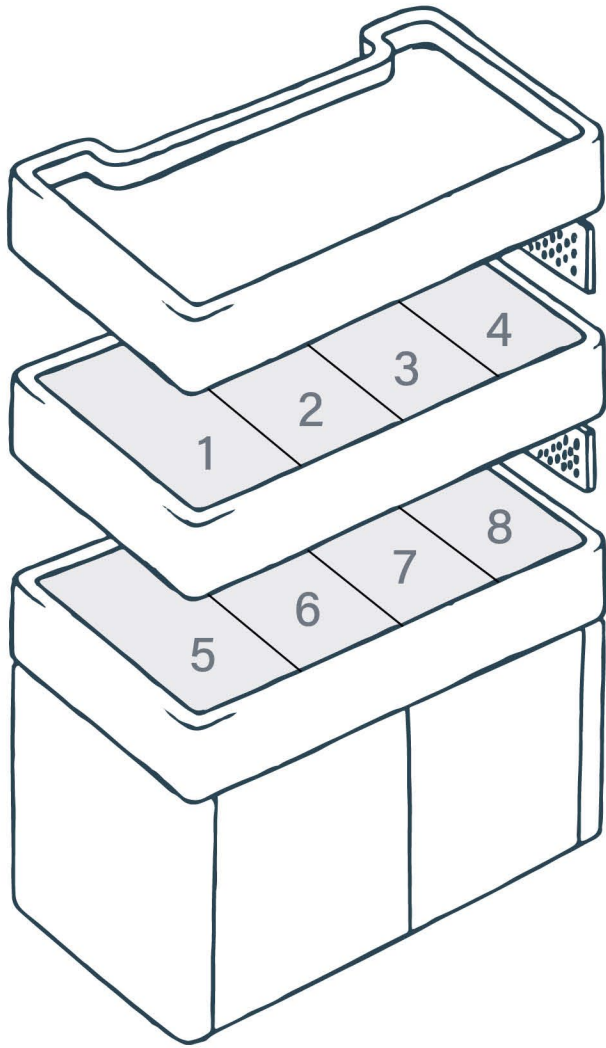





## Before You Start: Understanding Your Growing Space





The following schedule provides detailed bi-weekly instructions for each of the 12 growing slots shown in this diagram. Note that there will be some weeks when growing spots are empty. This ensures that your Living Lettuce and Living Herbs will have room to grow as they mature.

# Day 1

 Start  Growing  Transplant  Harvest





Tray 1  MG Start Microgreens.	Tray 2  L Start 8 Heads Lettuce (Mix of Varieties).	Tray 3	Tray 4
Tray 5	Tray 6	Tray 7  BG Start Babygreens.	Tray 8  H Start 9 Herbs Blocks (3 of each type).

# Day 7





Tray 1  MG Grow Microgreens.	Tray 2  L Grow Lettuce.	Tray 3	Tray 4
Tray 5	Tray 6	Tray 7  BG Grow Babygreens.	Tray 8  H Grow Herbs.

# Day 14

 Start  Growing  Transplant  Harvest









Tray 1  MG Harvest Microgreens.	Tray 2   L L Grow Lettuce. Start 8 Heads Lettuce (Mix of Varieties).	Tray 3	Tray 4
Tray 5	Tray 6	Tray 7  BG Grow Babygreens.	Tray 8  H Grow Herbs.

# Day 21

Tray 1  MG Start Microgreens.	Tray 2   L L Transplant 8 Heads Lettuce to blocks. Grow Lettuce.	Tray 3	Tray 4
Tray 5	Tray 6	Tray 7  BG Grow Babygreens.	Tray 8  H Grow Herbs.

# Day 28

 Start  Growing  Transplant  Harvest

<p>Tray 1</p>  <p>MG</p> <p>Grow Microgreens.</p>	<p>Tray 2</p>   <p>L L</p> <p>Start 8 Heads Lettuce (Mix of Varieties). Grow Lettuce.</p>	<p>Tray 3</p>  <p>L</p> <p>Move 4 Heads Lettuce from position 2 into position 3.</p>	<p>Tray 4</p>  <p>L</p> <p>Move 4 Heads Lettuce from position 2 into position 4.</p>
<p>Tray 5</p>	<p>Tray 6</p>	<p>Tray 7</p>   <p>BG BL</p> <p>Harvest Babygreens. Start Baby Leaf.</p>	<p>Tray 8</p>  <p>H</p> <p>Grow Herbs.</p>

---











*In order to continue producing gourmet greens with your Terrace Pro, you will need to re-order Grow Kits and refill your seeds and growing media stock. Visit [www.lesverts.com](http://www.lesverts.com) for a full complement of replacement kits, including all the delicious items you've been growing to date.*













# Day 35

● Start  
 ● Growing  
 ○ Transplant  
 ● Harvest









<p>Tray 1</p>   <p>MG    BG</p> <p>Harvest Microgreens. Start Babygreens.</p>	<p>Tray 2</p>   <p>L    L</p> <p>Grow Lettuce. Transplant 8 Heads Lettuce to blocks.</p>	<p>Tray 3</p>  <p>L</p> <p>Grow Lettuce.</p>	<p>Tray 4</p>  <p>L</p> <p>Grow Lettuce.</p>
<p>Tray 5</p>	<p>Tray 6</p>	<p>Tray 7</p>  <p>BL</p> <p>Grow Baby Leaf.</p>	<p>Tray 8</p>  <p>H</p> <p>Grow Herbs.</p>

# Day 42













<p>Tray 1</p>  <p>BG</p> <p>Grow Babygreens.</p>	<p>Tray 2</p>   <p>L    L</p> <p>Start 8 Heads Lettuce (Mix of Varieties). Grow Lettuce.</p>	<p>Tray 3</p>  <p>L</p> <p>Grow Lettuce.</p>	<p>Tray 4</p>  <p>L</p> <p>Grow Lettuce.</p>
<p>Tray 5</p>  <p>L</p> <p>Move 4 Heads Lettuce from position 2 into position 5.</p>	<p>Tray 6</p>  <p>L</p> <p>Move 4 Heads Lettuce from position 2 into position 6.</p>	<p>Tray 7</p>  <p>BL</p> <p>Grow Baby Leaf.</p>	<p>Tray 8</p>   <p>H    H</p> <p>Harvest Herbs. Start 9 Herbs Blocks (3 of each type).</p>

# Day 49

● Start  
 ● Growing  
 ○ Transplant  
 ● Harvest









Tray 1  BG	Grow Babygreens.	Tray 2   L   L	Transplant 8 Heads Lettuce to blocks. Grow Lettuce.	Tray 3  L	Grow Lettuce.	Tray 4  L	Grow Lettuce.
Tray 5  L	Grow Lettuce.	Tray 6  L	Grow Lettuce.	Tray 7  BL	Grow Baby Leaf.	Tray 8  H	Grow Herbs.

# Day 56











Tray 1  BG	Grow Babygreens.	Tray 2   L   L	Grow Lettuce. Start 8 Heads Lettuce (Mix of Varieties).	Tray 3   L   L	Harvest Lettuce. Move 4 Heads Lettuce from position 2 into position 3.	Tray 4   L   L	Harvest Lettuce. Move 4 Heads Lettuce from position 2 into position 4.
Tray 5  L	Grow Lettuce.	Tray 6  L	Grow Lettuce.	Tray 7   BL   BL	Harvest Baby Leaf. Start Baby Leaf.	Tray 8  H	Grow Herbs.

# Day 63

● Start  
 ● Growing  
 ○ Transplant  
 ● Harvest









<p>Tray 1</p>  <p>BG</p>	<p>Harvest Babygreens.</p>	<p>Tray 2</p>   <p>L L</p> <p>Transplant 8 Heads Lettuce to blocks.</p> <p>Grow Lettuce.</p>	<p>Tray 3</p>  <p>L</p> <p>Grow Lettuce.</p>	<p>Tray 4</p>  <p>L</p> <p>Grow Lettuce.</p>
<p>Tray 5</p>  <p>L</p> <p>Grow Lettuce.</p>	<p>Tray 6</p>  <p>L</p> <p>Grow Lettuce.</p>	<p>Tray 7</p>  <p>BL</p> <p>Grow Baby Leaf.</p>	<p>Tray 8</p>  <p>H</p> <p>Grow Herbs.</p>	

# Day 70











<p>Tray 1</p>	<p>Tray 2</p>   <p>L L</p> <p>Start 8 Heads Lettuce (Mix of Varieties)</p> <p>Grow Lettuce.</p>	<p>Tray 3</p>  <p>L</p> <p>Grow Lettuce.</p>	<p>Tray 4</p>  <p>L</p> <p>Grow Lettuce.</p>
<p>Tray 5</p>   <p>L L</p> <p>Harvest Lettuce.</p> <p>Move 4 Heads Lettuce from position 2 into position 5.</p>	<p>Tray 6</p>   <p>L L</p> <p>Harvest Lettuce.</p> <p>Move 4 Heads Lettuce from position 2 into position 6.</p>	<p>Tray 7</p>  <p>BL</p> <p>Grow Baby Leaf.</p>	<p>Tray 8</p>  <p>H</p> <p>Grow Herbs.</p>

# Day 77

 Start  Growing  Transplant  Harvest







<p>Tray 1</p>  <p>MG</p>	<p>Start Microgreens.</p>	<p>Tray 2</p>   <p>L L</p>	<p>Transplant 8 Heads Lettuce to blocks.</p> <p>Grow Lettuce.</p>	<p>Tray 3</p>  <p>L</p>	<p>Grow Lettuce.</p>	<p>Tray 4</p>  <p>L</p>	<p>Grow Lettuce.</p>
<p>Tray 5</p>  <p>L</p>	<p>Grow Lettuce.</p>	<p>Tray 6</p>  <p>L</p>	<p>Grow Lettuce.</p>	<p>Tray 7</p>  <p>BL</p>	<p>Grow Baby Leaf.</p>	<p>Tray 8</p>  <p>H</p>	<p>Grow Herbs.</p>

# Day 84







<p>Tray 1</p>  <p>MG</p>	<p>Grow Microgreens.</p>	<p>Tray 2</p>  <p>L</p>	<p>Grow Lettuce.</p>	<p>Tray 3</p>   <p>L L</p>	<p>Harvest Lettuce.</p> <p>Move 4 Heads Lettuce from position 2 into position 3.</p>	<p>Tray 4</p>   <p>L L</p>	<p>Harvest Lettuce.</p> <p>Move 4 Heads Lettuce from position 2 into position 4.</p>
<p>Tray 5</p>  <p>L</p>	<p>Grow Lettuce.</p>	<p>Tray 6</p>  <p>L</p>	<p>Grow Lettuce.</p>	<p>Tray 7</p>  <p>BL</p>	<p>Harvest Baby Leaf.</p>	<p>Tray 8</p>  <p>H</p>	<p>Harvest Herbs (partial or whole harvest).</p>

# Day 91

 Start  Growing  Transplant  Harvest



Tray 1  MG Harvest Microgreens.	Tray 2  L Transplant 8 Heads Lettuce to blocks.	Tray 3  L Grow Lettuce.	Tray 4  L Grow Lettuce.
Tray 5  L Grow Lettuce.	Tray 6  L Grow Lettuce.	Tray 7	Tray 8



# Day 98

Tray 1	Tray 2	Tray 3  L Grow Lettuce.	Tray 4  L Grow Lettuce.
Tray 5  L  L Harvest Lettuce. Move 4 Heads Lettuce from position 2 into position 5.	Tray 6  L  L Harvest Lettuce. Move 4 Heads Lettuce from position 2 into position 6.	Tray 7	Tray 8



# Day 105



 Start  Growing  Transplant  Harvest

Tray 1  MG Start Microgreens.	Tray 2	Tray 3  L Grow Lettuce.	Tray 4  L Grow Lettuce.
--	--------	---	---

Tray 5  L Grow Lettuce.	Tray 6  L Grow Lettuce.	Tray 7	Tray 8
--	---	--------	--------

# Day 112



Tray 1  MG Grow Microgreens.	Tray 2	Tray 3  L Harvest Lettuce.	Tray 4  L Harvest Lettuce.
---	--------	--	--

Tray 5  L Grow Lettuce.	Tray 6  L Grow Lettuce.	Tray 7	Tray 8
--	---	--------	--------

# Day 119

 Start  Growing  Transplant  Harvest



Tray 1  MG Harvest Microgreens.	Tray 2	Tray 3	Tray 4
--	--------	--------	--------

Tray 5  L Grow Lettuce.	Tray 6  L Grow Lettuce.	Tray 7	Tray 8
--	---	--------	--------

# Day 126

---

Tray 1	Tray 2	Tray 3	Tray 4
--------	--------	--------	--------

Tray 5  L Harvest Lettuce.	Tray 6  L Harvest Lettuce.	Tray 7	Tray 8
---	--	--------	--------